

TIME 40 ROUND

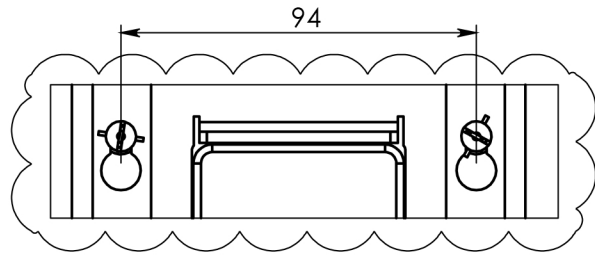

Rear view - wall clock mounting

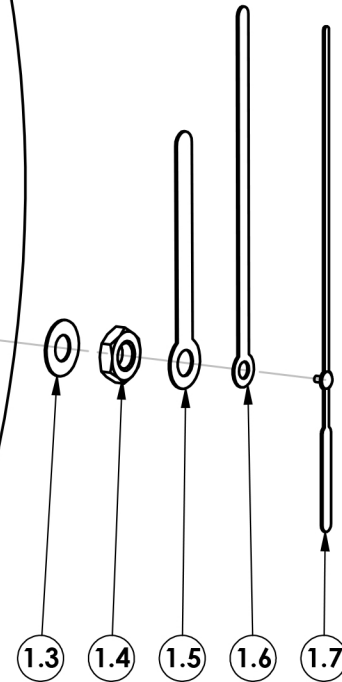
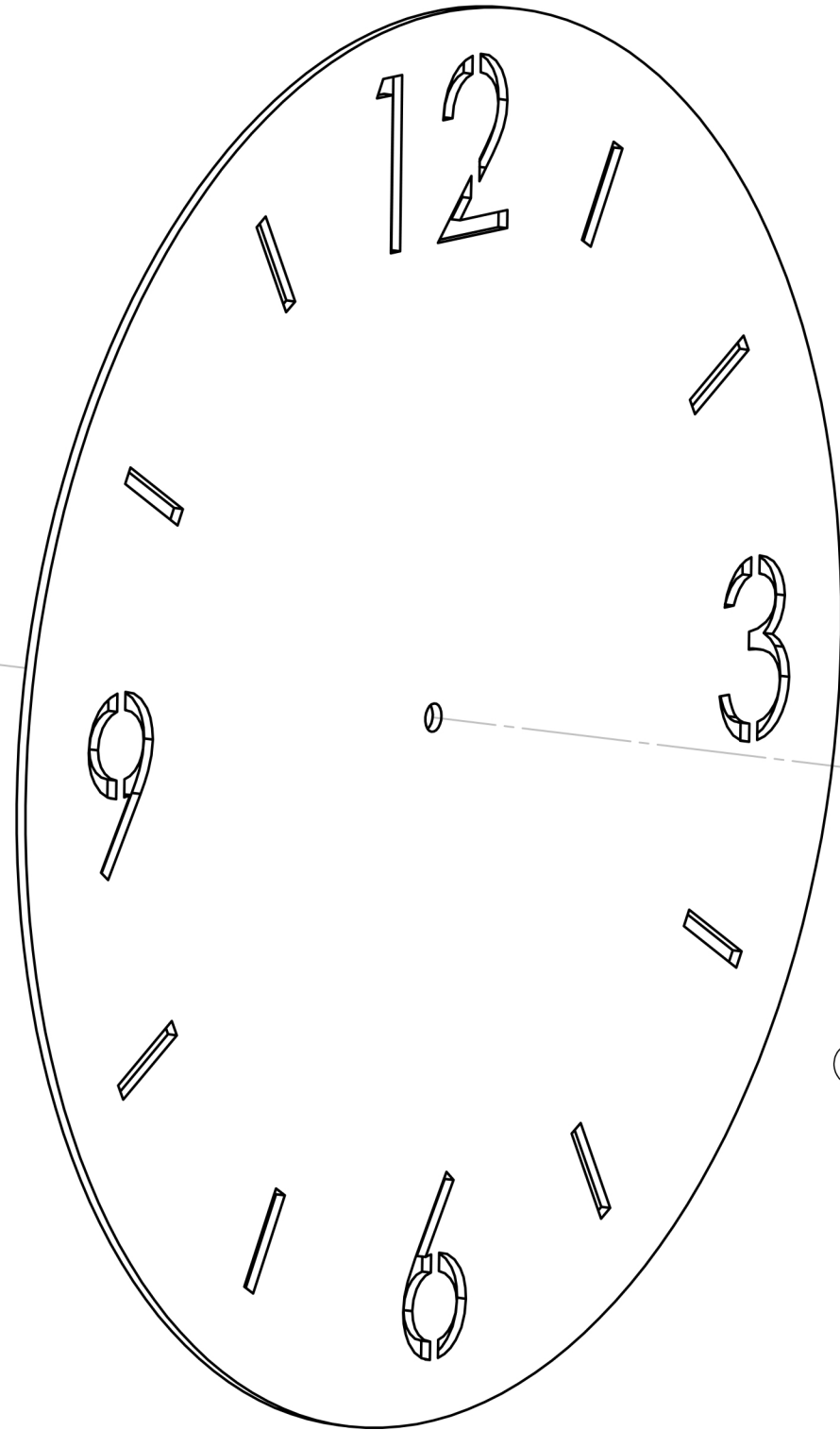
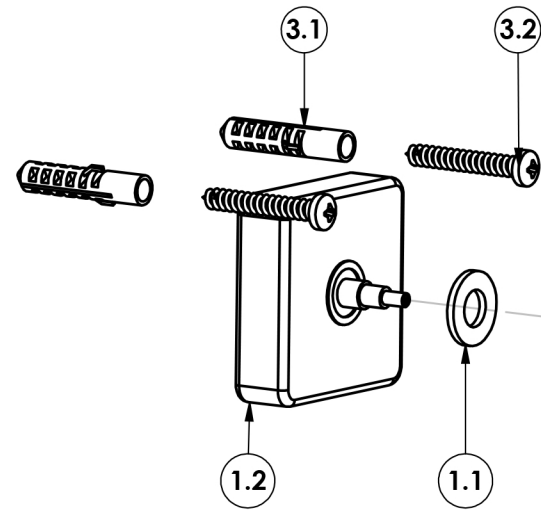

Pack 1

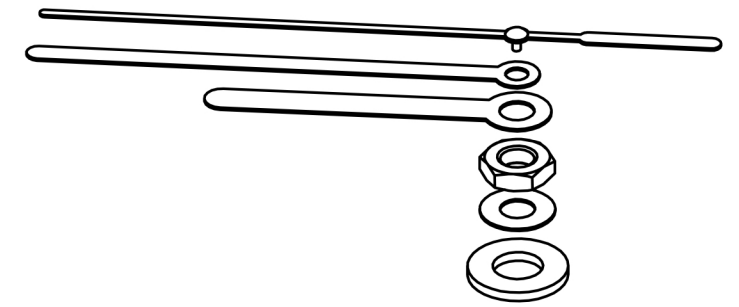

Watch components

Pack 2

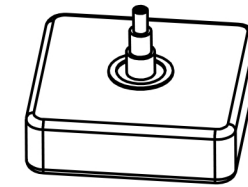

Clock mechanism

Pack 3

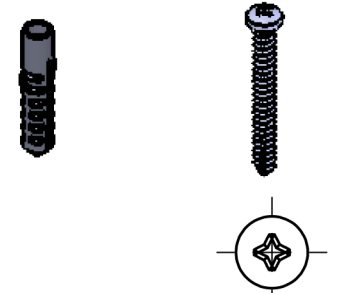

∅ 8 x 40
2 pcs

∅ 5 x 40 Pz2
2 pcs

STEP 1

Mount the elements 3.1 and 3.2 on the wall.

STEP 2

- 1.1 Place rubber cushion over shaft.
- 1.2 Insert shaft through clock face.
- 1.3 Place dial plate washer over shaft.
- 1.4 Attach dial fixing hex nut.
- 1.5 Attach hour hand and press lightly.
- 1.6 Attach minute hand.
- 1.7 Press second hand in place.

Insert a fresh battery (not included) and your clock will begin to keep time. The time can be set by turning the time-set knob on the back of the clock movement.

STEP 3

Hang the clock on the wall.



∅ 8

PZ 2