

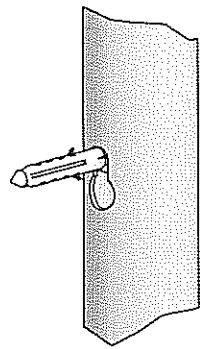

1

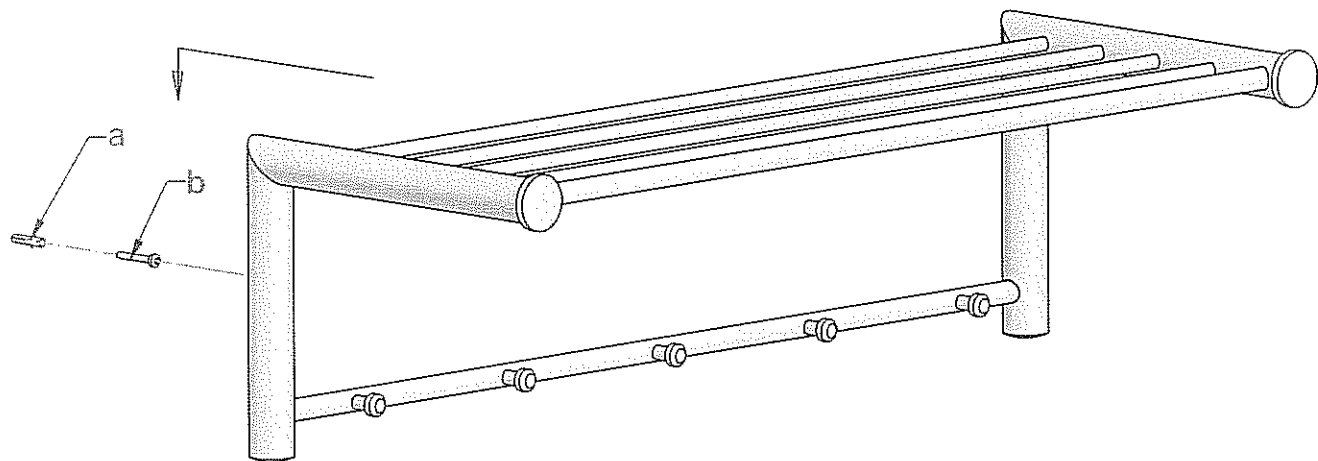

2

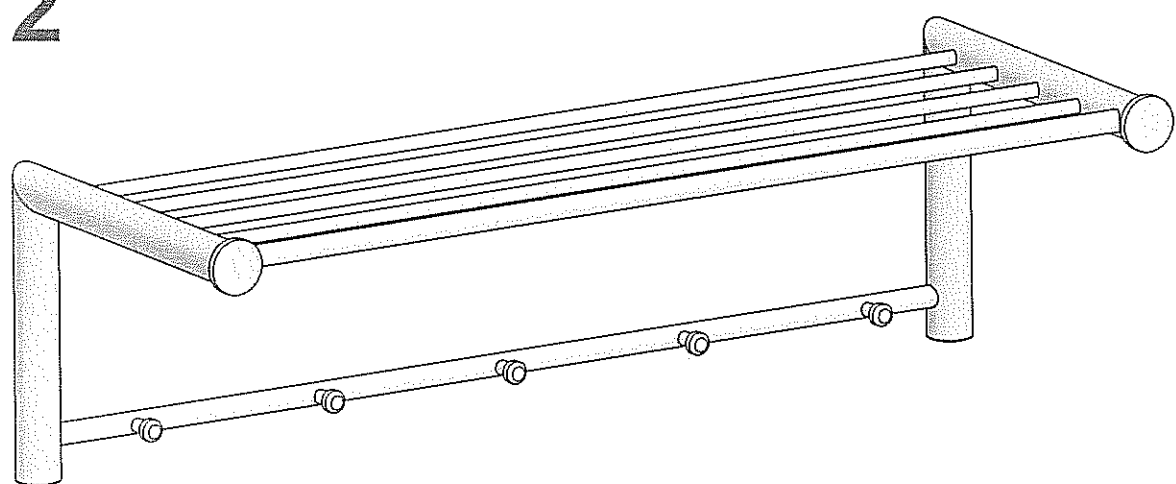

a 2x



b 2x

Suza 3 Wandkapstok

GW582-62

